

HF 4SRHF



Push-pull female couplings for agriculture with higher flow rate, up to 250 l/min.

Push-pull female couplings for high flow rate applications, connectable under residual pressure in both male and female side. Can be screwed directly into valve ports or rigid pipes. Breakaway function. ISO 7241 part A interchange. Flow rate up to 250 l/min.



Applications



Pressure Drop

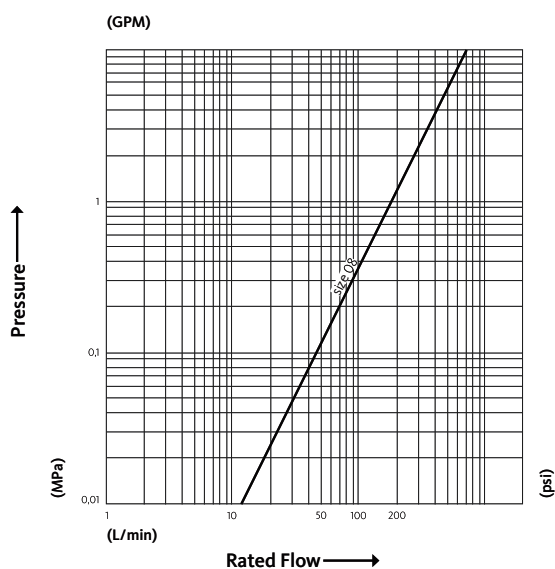

Test performed according to ISO 18869

Technical Specifications

dash	Size		Working Pressure (MPa)	Flow Rate (l/min)	Spillage (ml)	Force to Connect (N)	Burst pressure (MPa)		
	mm	inch					Male	Female	Male + Female
08	12.5	1/2"	25	70	2	250	100	100	

Material	Steel
Seals	PUR
Working temperatures	- 25 °C to + 100 °C
Surface treatment	MATE 500 (CrIII)
Series Interchange	ISO 7241 part A

Valve Type	Poppet
Connection	Push to Connect
Disconnection	Pull to Disconnect
Connection Under Pressure	Allowed Both Halves up to W.P.



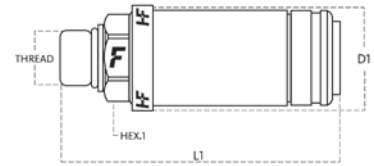

4SRHF

Size		Thread details			FEMALE							
mm	inch	Thread Type	Standard	Thread	Part Number	L (L1 + Thread)		D1		HEX1		
						mm	inch	mm	inch	mm	inch	
12.5	1/2"	01/ SAE	ISO 11926-3	3/4"-16 UNF MALE	4SRHF081/12SAE F	108.2	4.26	42	1.65	32	1.26	
12.5	1/2"	07/ METRIC	ISO 8434-1-L	M22x1.5 MALE BULKHEAD SHORT 15L	4SRHF087/2215 F	122.4	4.82	32	1.26	42	1.65	
12.5	1/2"	07/ METRIC	ISO 8434-1-L	M18x1.5 MALE BULKHEAD SHORT 12L	4SRHF087/1815 F	121.2	4.77	42	1.65	32	1.26	
12.5	1/2"	19/ METRIC	DIN 7642	M22x1.5 MALE	4SRHF0819/2215 F	133.7	5.26	42	1.65	32	1.26	
12.5	1/2"	F NPTF	ANSI B1.20.3	NPTF 1/2" FEMALE	4SRHF08 12NPT F	106.2	4.18	42	1.65	27	1.06	
12.5	1/2"	F BSPP	ISO 1179-1	BSPP 1/2" FEMALE	4SRHF08 12GAS F	106.2	4.18	42	1.65	27	1.06	
12.5	1/2"	01/ METRIC	ISO 6149-2	M22x1.5 MALE	4SRHF081/2215 F	109.7	4.32	42	1.65	32	1.26	
12.5	1/2"	01/ METRIC	ISO 6149-2	M18x1.5 MALE	4SRHF081/1815 F	112.2	4.42	42	1.65	32	1.26	
12.5	1/2"	21/ METRIC	ISO 9974-2	M22x1.5 MALE	4SRHF0821/2215 F	109.2	4.3	42	1.65	32	1.26	
12.5	1/2"	04/ BSPP	ISO 8434-6	BSPP 5/8 MALE BULKHEAD	4SRHF084/58GF H	129.7	5.11	42	1.65	32	1.26	
12.5	1/2"	04/ BSPP	ISO 8434-6	BSPP 3/8 MALE BULKHEAD	4SRHF084/38GF H	129.7	5.11	42	1.65	32	1.26	
12.5	1/2"	04/ BSPP	ISO 8434-6	BSPP 1/2 MALE BULKHEAD	4SRHF084/12GF H	130.2	5.13	42	1.65	32	1.26	
12.5	1/2"	22/ BSPP	BS 5200	BSPP 3/8 MALE	4SRHF0822/38GFH	109.2	4.3	42	1.65	32	1.26	
12.5	1/2"	14/ SAE	ISO 8434-2	7/8"-14 UNF MALE BULKHEAD JIC	4SRHF0814/58SFH	127.7	5.03	42	1.65	32	1.26	
12.5	1/2"	01/ METRIC	ISO 6149-2	M22x1.5 MALE	4SRHF081/22FVAC	109.7	4.32	42	1.65	32	1.26	
12.5	1/2"	0/ SAE	ISO 11926-1	3/4"-16 UNF FEMALE ORB	4SRHF08 12SF H	106.2	4.18	42	1.65	27	1.06	
12.5	1/2"	12/ SAE	ISO 8434-3	1-3/16"-12 UN MALE BULKHEAD ORFS	4SRHF0812/34SFH	132	5.20	42	1.65	36	1.42	

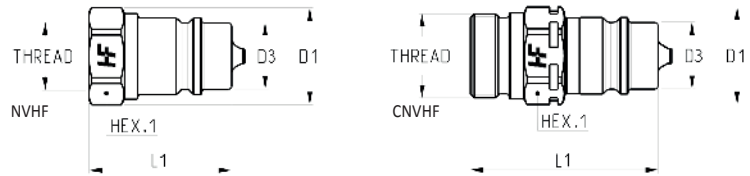

Size		Thread details			MALE								
mm	inch	Thread Type	Standard	Thread	Part Number	L (L1 + Thread)		D1		D3		HEX1	
						mm	inch	mm	inch	mm	inch	mm	inch
12.5	1/2"	F BSPP	ISO 1179-1	BSPP 1/2 FEMALE	NVHF08 GAS M	44	1.73	30	1.18	20.5	0.81	27	1.06
12.5	1/2"	F BSPP	ISO 1179-1	BSPP 3/8 FEMALE	CNVHF08 38GAS M	57	2.24	30	1.18	20.5	0.81	27	1.06
12.5	1/2"	02/ METRIC	ISO 8434-1-L	M18x1.5 MALE 12L	CNVHF082/1815 M	57	2.24	30	1.18	20.5	0.81	27	1.06
12.5	1/2"	02/ METRIC	ISO 8434-1-L	M22x1.5 MALE 15L	CNVHF082/2215 M	58	2.28	30	1.18	20.5	0.81	27	1.06
12.5	1/2"	02/ METRIC	ISO 8434-1-L	M26x1.5 MALE 18L	CNVHF082/2615 M	58	2.28	30	1.18	20.5	0.81	27	1.06

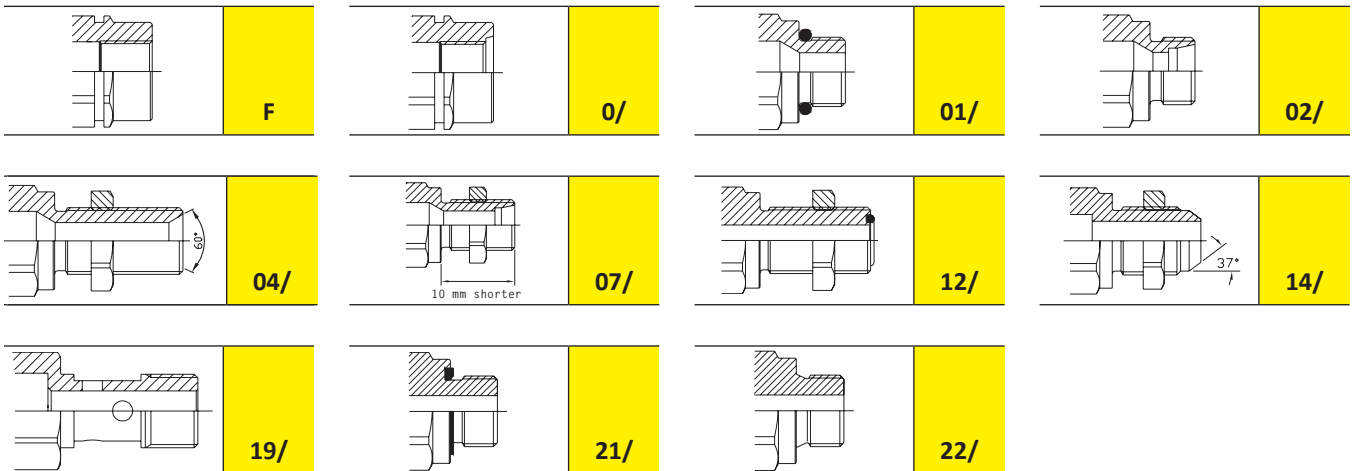

4SRHF Accessories and Spares



PVC dust protections



Acetal Resin dust protections

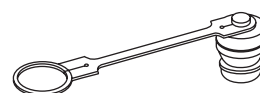

Aluminium dust protections

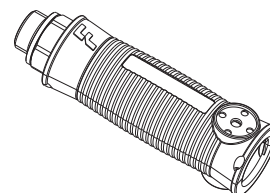

Line Identification System

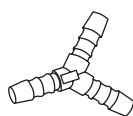
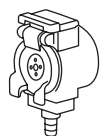

Modular automatic caps with Oil Collecting System



Seals Kits