

# HF 3CFHF



**Push-pull female coupling for agriculture connectable with male half under residual pressure.**

This series, compliant with ISO 7241 part A, can be screwed directly into valve ports or rigid pipes and offers the breakaway function (no hose break in case of unintentional hose pulling exerted by the tractor, thanks to disconnection of the male half). The valve seal resists to extrusion for back-flow up to 250 l/m.



## Applications



## Pressure Drop

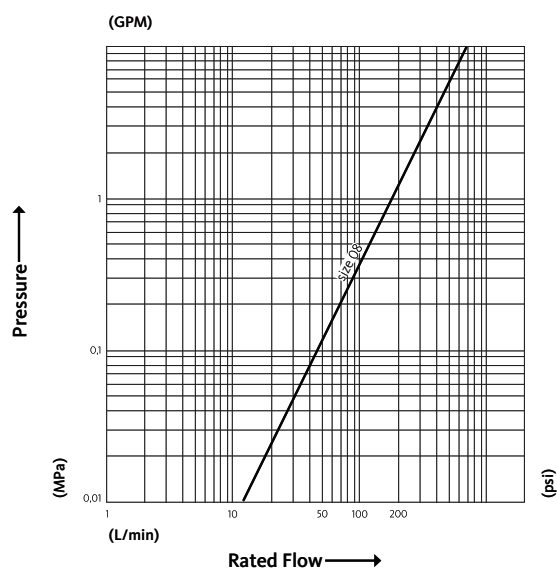

Test performed according to ISO 18869

## Technical Specifications

dash	Size mm	inch	Working Pressure (MPa)	Flow Rate (l/min)	Spillage (ml)	Force to Connect (N)	Burst pressure (MPa)		
							Male	Female	Male + Female
08	12.5	1/2"	25	70	2	250	100	110	

Material	<b>Steel</b>
Seals	<b>PUR</b>
Working temperatures	<b>- 25 °C to + 100 °C</b>
Surface treatment	<b>MATE 500 (CrIII)</b>
Series Interchange	<b>ISO 7241 part A</b>

Valve Type	<b>Poppet</b>
Connection	<b>Push to Connect</b>
Disconnection	<b>Pull to Disconnect</b>
Connection Under Pressure	<b>Allowed Male Half up to W.P.</b>



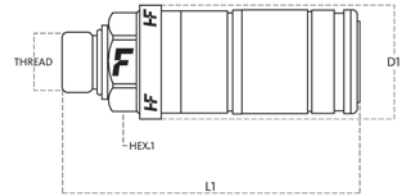

# 3CFHF

Size		Thread details			FEMALE						
mm	inch	Thread Type	Standard	Thread	Part Number	L (L1 + Thread)		D1		HEX1	
						mm	inch	mm	inch	mm	inch
12.5	1/2"	01/ SAE	ISO 11926-3	3/4"-16 UNF MALE	3CFHF081/12SAE F	108.2	4.26	42	1.65	32	1.26
12.5	1/2"	07/ METRIC	ISO 8434-1-L	M22x1.5 MALE BULKHEAD SHORT 15L	3CFHF087/2215 F	122.4	4.82	42	1.65	32	1.26
12.5	1/2"	07/ METRIC	ISO 8434-1-L	M18x1.5 MALE BULKHEAD SHORT 12L	3CFHF087/1815 F	121.2	4.77	42	1.65	32	1.26
12.5	1/2"	19/ METRIC	DIN 7642	M22x1.5 MALE	3CFHF0819/2215 F	134.7	5.3	42	1.65	32	1.26
12.5	1/2"	F NPTF	ANSI B1.20.3	NPTF 1/2" FEMALE	3CFHF08 12NPT F	106.2	4.18	42	1.65	27	1.06
12.5	1/2"	F BSPP	ISO 1179-1	BSPP 1/2" FEMALE	3CFHF08 12GAS F	106.2	4.18	42	1.65	27	1.06
12.5	1/2"	01/ METRIC	ISO 6149-2	M22x1.5 MALE	3CFHF081/2215 F	109.7	4.32	42	1.65	32	1.26
12.5	1/2"	01/ METRIC	ISO 6149-2	M18x1.5 MALE	3CFHF081/1815 F	112.2	4.42	42	1.65	32	1.26
12.5	1/2"	21/ METRIC	ISO 9974-2	M22x1.5 MALE	3CFHF0821/2215 F	109.2	4.3	42	1.65	32	1.26
12.5	1/2"	21/ METRIC	ISO 9974-2	M22x1.5 MALE	3CFHF21/22F U	109.2	4.3	42	1.65	32	1.26
12.5	1/2"	14/ SAE	ISO 8434-2	7/8"-14 UNF MALE BULKHEAD JIC	3CFHF14/78UNFF	127.7	5.03	42	1.65	32	1.26
12.5	1/2"	14/ SAE	ISO 8434-2	3/4"-16 UN MALE BULKHEAD JIC	3CFHF14/78UFVAL	162	6.38	42	1.65	32	1.26
12.5	1/2"	14/ SAE	ISO 8434-2	1-1/16"-12 UN MALE BULKHEAD JIC	3CFHF14/34UNFF	123.7	4.87	42	1.65	32	1.26
12.5	1/2"	F NPTF	ANSI B1.20.3	NPTF 1/2" FEMALE	3CFHF12NPT F T	106.2	4.18	42	1.65	27	1.06
12.5	1/2"	12/ SAE	ISO 8434-3	1"-14 UNS MALE BULKHEAD ORFS	3CFHF12/1UNSFU	129.2	5.09	42	1.65	32	1.26
12.5	1/2"	12/ SAE	ISO 8434-3	1"-14 UNS MALE BULKHEAD ORFS	3CFHF12/1UNS F	129.2	5.09	42	1.65	32	1.26
12.5	1/2"	01/ SAE	ISO 11926-3	7/8"-14 UNF MALE	3CFHF1/78UNF F	107.4	4.23	42	1.65	32	1.26
12.5	1/2"	01/ METRIC	ISO 6149-2	M22x1.5 MALE	3CFHF1/2215FJDC	109.7	4.32	40	1.57	38	1.5
12.5	1/2"	01/ METRIC	ISO 6149-2	M22x1.5 MALE	3CFHF1/2215F B	109.7	4.32	42	1.65	32	1.26
12.5	1/2"	04/ BSPP	ISO 8434-6	BSPP 3/8 MALE BULKHEAD	3CFHF0874/38GF	108.2	4.26	42	1.65	32	1.26
12.5	1/2"	07/ METRIC	ISO 8434-1-L	M26x1.5 MALE BULKHEAD SHORT 18L	3CFHF087/2615F	125.2	4.93	42	1.65	32	1.26
12.5	1/2"	07/ METRIC	ISO 8434-1-L	M22x1.5 MALE BULKHEAD SHORT 15L	3CFHF087/22FAG	137.6	5.42	40	1.57	38	1.5
12.5	1/2"	22/ BSPP	BS 5200	BSPP 1/2 MALE	3CFHF0822/12G FL	111.2	4.38	38	1.5	32	1.26
12.5	1/2"	21/ BSPP	ISO 1179-2	1/8" BSPP MALE	3CFHF0821/18FU	108.7	4.28	42	1.65	32	1.26
12.5	1/2"	01/ BSPP	BS 5380	G 5/8"	3CFHF081/58S F	108.7	4.28	42	1.65	32	1.26
12.5	1/2"	01/ BSPP	BS 5380	G 1/2"	3CFHF081/12G F	109.7	4.32	42	1.65	32	1.26
12.5	1/2"	08/ METRIC	ISO 8434-1-S	M24x1.5 MALE BULKHEAD SHORT 16S	3CFHF 8/2415 F	120.4	4.74	42	1.65	32	1.26
12.5	1/2"	0/ SAE	ISO 11926-1	3/4" - 16 UNF FEMALE ORB	3CFHF 34 UNF F	106.2	4.18	42	1.65	27	1.06
12.5	1/2"	01/ SAE	ISO 11926-3	1-1/16"-12 UN MALE	3CFHF1/34UNF F	123.7	4.87	42	1.65	32	1.26
12.5	1/2"	01/ METRIC	ISO 6149-2	M22x1.5 MALE	3CFHF1/2215F A	109.7	4.32	42	1.65	32	1.26
12.5	1/2"	01/ METRIC	ISO 6149-2	M22x1.5 MALE	3CFHF1/2215 FAG	109.7	4.32	42	1.65	32	1.26
12.5	1/2"	11/ SAE	ISO 8434-3	13/16"-16 UN MALE ORFS	3CFHF0811/12SFJ	110.2	4.34	40	1.57	38	1.50
12.5	1/2"	02/ METRIC	ISO 8434-1-L	M22x1.5 MALE 15L	3CFHF082/22F D	116.9	4.60	42	1.65	32	1.26
12.5	1/2"	07/ METRIC	ISO 8434-1-L	M18x1.5 MALE BULKHEAD SHORT 12L	3CFHF087/18F U	122.4	4.82	42	1.65	32	1.26
12.5	1/2"	07/ METRIC	ISO 8434-1-L	M22x1.5 MALE BULKHEAD SHORT 15L	3CFHF087/22F U	122.4	4.82	42	1.65	32	1.26
12.5	1/2"	01/ METRIC	ISO 6149-2	M22x1.5 MALE	3CFHF1/2215F C	109.7	4.32	40	1.57	38	1.50

# 3CFHF

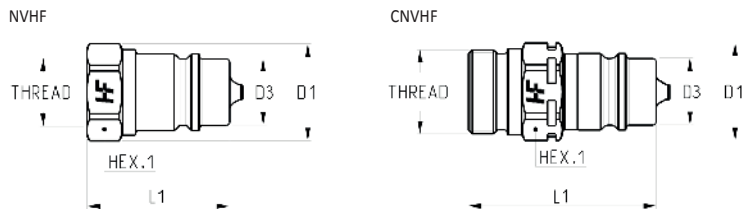

Size		Thread details			MALE									
mm	inch	Thread Type	Standard	Thread	Part Number	L (L1 + Thread)		D1		D3		HEX1		
						mm	inch	mm	inch	mm	inch	mm	inch	
12.5	1/2"	F BSPP	ISO 1179-1	BSPP 1/2 FEMALE	NVHF08 GAS M	44	1.73	30	1.18	20.5	0.81	27	1.06	
12.5	1/2"	F BSPP	ISO 1179-1	BSPP 3/8 FEMALE	CNVHF08 38GAS M	57	2.24	30	1.18	20.5	0.81	27	1.06	
12.5	1/2"	O2/ METRIC	ISO 8434-1-L	M18x1.5 MALE 12L	CNVHF082/1815 M	57	2.24	30	1.18	20.5	0.81	27	1.06	
12.5	1/2"	O2/ METRIC	ISO 8434-1-L	M22x1.5 MALE 15L	CNVHF082/2215 M	58	2.28	30	1.18	20.5	0.81	27	1.06	
12.5	1/2"	O2/ METRIC	ISO 8434-1-L	M26x1.5 MALE 18L	CNVHF082/2615 M	58	2.28	30	1.18	20.5	0.81	27	1.06	

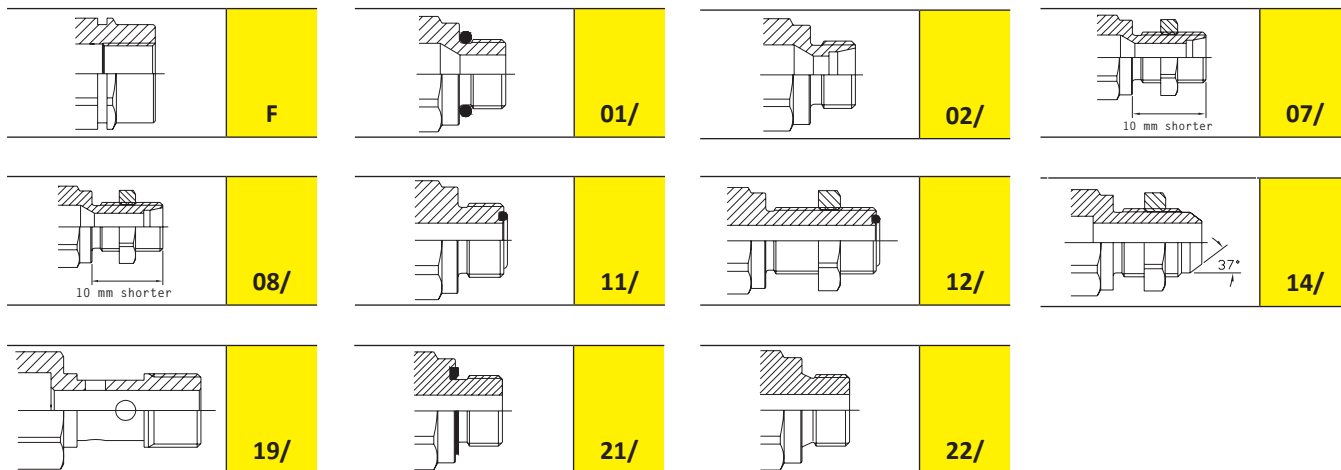

## 3CFHF Accessories and Spares



---

### PVC dust protections



---

### Acetal Resin dust protections

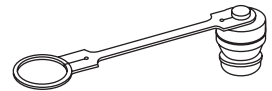

---

### Aluminium dust protections

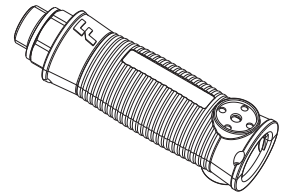

---

### Line Identification System

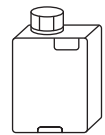
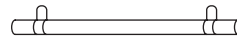
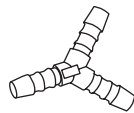
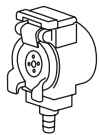

---

### Modular automatic caps with Oil Collecting System



---

### Seals Kits